

Important: Read all instructions prior to installation.

Linear LED High Bay Light

Summary

Industrial LED lights are the heavy-duty, super-bright alternative to traditional HID or tube light fixtures. Perfect for warehouse lighting, parking garage lighting, tunnel lighting, gym lighting, factory floor, supermarket lighting, and more, this dual 28" low-bay/high-bay LED light has 168 Nichia LEDs with an output of 19,500 lumens. Unlike circular industrial lights with a round beam pattern, this linear fixture has natural white LEDs that emit a 60° x 90° oval beam of light to fully illuminate aisles shelving and other narrow, long spaces.

Use two HBL-HK suspension cable kits to hang your dual 28" High-Output Linear LED Light Fixture.



Specifications

HBDL-50K180W-6090	
Intensity	19500 Lumens
Replacement for	500 Watt MH
Comparable Incandescent Wattage	1950 Watts
Total Power Consumption	180 Watts
Current Draw Max	2.1 Amps
Color Temperature	5000 K, Natural White
Beam Angle	60 degree / 90 degree
CRI	72 CRI
Dimmable	No
Connection Type	Pigtail
IP Rating	Weatherproof IP65
LED Brand / Quantity	Nichia / 168 LEDs
Operating Voltage Range	100-277 VAC
Operating Temperature	-22°-122°F (-30°~50°C)
Standards And Certifications	CE /SAA/UL Listed
Warranty	5 year

HBDL-MB (Included)	
Type	Bracket Mounting

HBL-HK (Not Included)	
Length	76 in (6.4ft)
Type	Suspension Kit

Ceiling Mounted Installation

HBDL-MB (included)

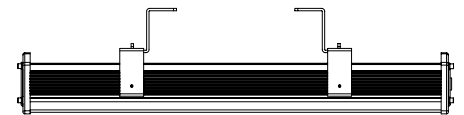
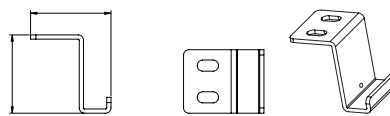

1.

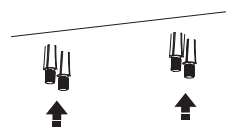

2.

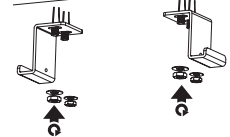

3.

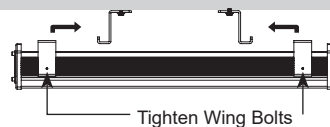

4.

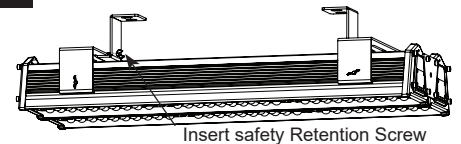

Wire Suspension Installation

HBL-HK (Optional two sets required)

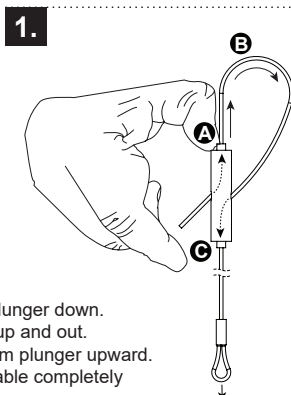
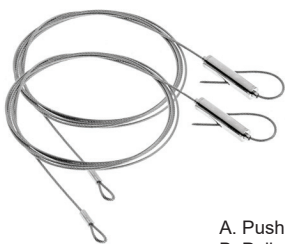

2.

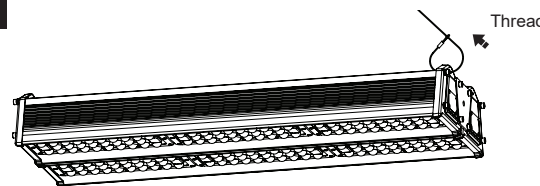

4.

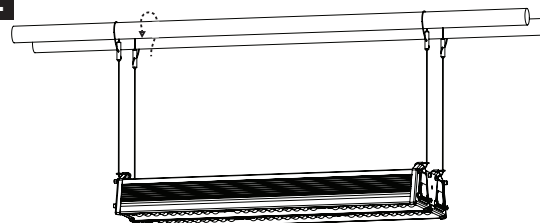

3.

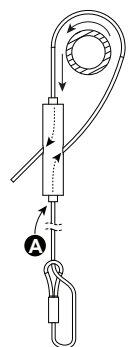

Important: Read all instructions prior to installation.

Linear LED High Bay Light

Dimensions

Dimensional Drawing HBDL-50K180W-6090

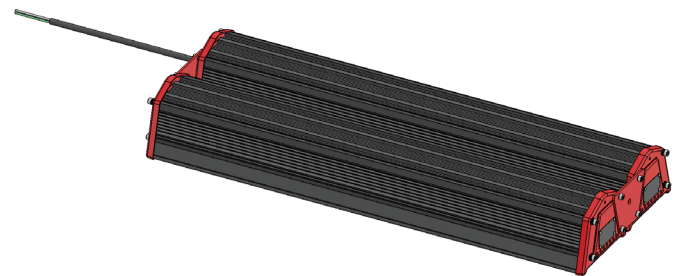
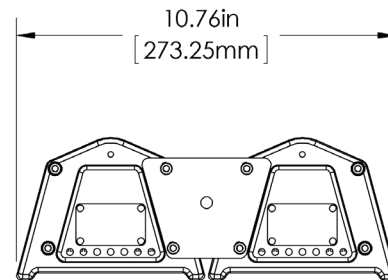
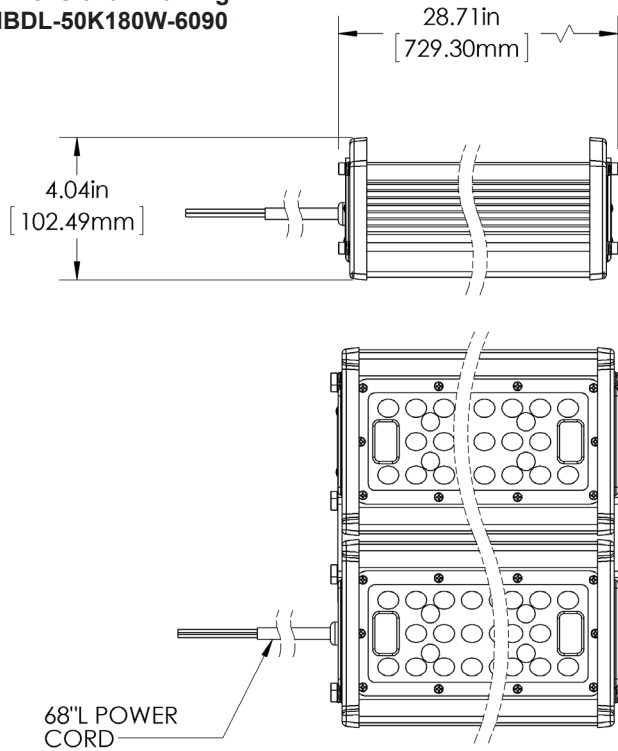

Suspension Cables for 180W Linear High Bay LED Light HBL-HK

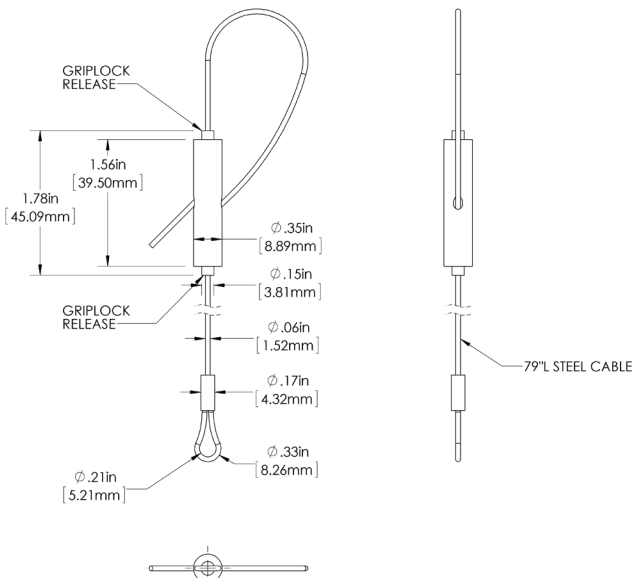

Adjustable Mounting Brackets for 180W Linear High Bay LED Light HBDL-MB

