

COB Series LED Strip Lights

Single Color/CCT, Tunable CCT, and RGB Strips

Project _____

Date _____ Type _____



Description

COB Series LED strip lights are designed to produce a smooth, seamless line of light with options to suit both wet and dry locations. Chip-on-board technology reduces heat build up for extended life, is more flexible, and has a higher density of LEDs for a more intense, uniform light. The superior design shows no visible dots or hot spots—even without a diffuser—making it ideal for reflective surfaces such as granite countertops and tile floors.

Construction

- Flexible COB design for highly adaptable mounting
- High density design for dot-free light solution
- Adhesive backing

Electrical

- 24 VDC or 12 VDC input available on most versions
- 0-100% dimmable
- IP65 versions feature 5.5 mm x 2.1 mm barrel connector and included 22 AWG pigtail adapter

Photometrics

- Single color, single CCT, tunable CCT, and RGB versions
- Wide 180° beam angle

Available Versions

Non-Weatherproof 24 V Single CCT

- STN-A22K90-O32-08L5M-24V
- STN-A27K90-O32-08L5M-24V
- STN-A30K90-O32-08L5M-24V
- STN-A40K90-O32-08L5M-24V
- STN-A50K90-O32-08L5M-24V
- STN-A65K90-O32-08L5M-24V

Weatherproof Single CCT

- STW-A22K90-O32D-08L5M-24V
- STW-A27K90-O32D-08L5M-24V
- STW-A30K90-O32D-08L5M-24V
- STW-A40K90-O32D-08L5M-24V
- STW-A50K90-O32D-08L5M-24V
- STW-A65K90-O32D-08L5M-24V

Non-Weatherproof Single Color

- STN-BBLU-O32A-08L5M-24V
- STN-BGRE-O32A-08L5M-24V
- STN-BRED-O32A-08L5M-24V

Weatherproof Single Color

- STW-BBLU-O32D-08L5M-24V
- STW-BGRE-O32D-08L5M-24V
- STW-BRED-O32D-08L5M-24V

Non-Weatherproof 12 V Single CCT

- STN-A22K90-O18A-08P5M-12V
- STN-A27K90-O18A-08P5M-12V
- STN-A30K90-O18A-08P5M-12V
- STN-A40K90-O18A-08P5M-12V
- STN-A50K90-O18A-08P5M-12V
- STN-A65K90-O18A-08P5M-12V

RGB

- STN-CRGB-O63A-12R5M-24V

Tunable CCT

- STN-H90-O42A-12Q5M-24V

Accessories

Super Bright LEDs offers a variety of controllers, mounting, and wiring solutions compatible with COB series strips as well as premium quality DiodeDrive power supplies to complete any type of installation.

Applications

Some common applications include sign and display lighting, edge lighting, cove lighting, backlighting, theater lighting, retail lighting, and accent lighting for design and architectural applications. Due to their unique design these are especially well suited for use with reflective materials such as granite, tile, and glass as well.

SAMPLE PART NUMBER BREAKDOWN

STN-A22K90-O32-08L5M-24V

FAMILY / CATEGORY / COLOR				LED TYPE / SEGMENT		IP RATING	SIZE / DENSITY / VOLTAGE			
STN Strip Type	A Strip Type	22K Color	90 CRI	O LED Type	32 LED/Segment	A IP Rating	08 Strip Width*	L Density	5M Length	24V Voltage
STN: Non-weatherproof STW: Weatherproof	A: Single White B: Single Color C: RGB H: Selectable CCT	22K: 3000K 27K: 2700K 30K: 3000K 40K: 4000K 50K: 5000K 65K: 6500K BLU: Blue GRE: Green RED: Red RGB: RGB blank: N/A	90: 90-94 blank: N/A	O: COB	18: 18 LEDs/seg 32: 32 LEDs/seg 42: 42 LEDs/seg 63: 63 LEDs/seg	blank: IP20 A: IP20 D: IP65	08: 8 mm 12: 12 mm	L: 512 LEDs/m P: 504 LEDs/m Q: 1,008 LEDs/m R: 1,134 LEDs/m	5M: 16.4 ft (5 m)	24V: 24 V 12V: 12 V
<p>*Strip width represents the width of the strip itself and does not necessarily correlate to the total physical width of the product (e.g. STW strips will show 8 mm strip width, but will actually measure 10 mm due to weatherproof coating)</p>										



T 866.811.5550

F 314.972.6202

email: commercial-sales@superbrightleds.com

https://www.superbrightleds.com/cat/led-strips-and-bars/

Rev. V4 Date: 10/12/2021

Specifications are subject to change without notice.

Printed in the U.S.A.

COB Series LED Strip Lights

Single Color/CCT, Tunable CCT, and RGB Strips

Specifications

Model	ALL
Beam Angle	180°
Max Run	16.4 ft (5 m)
LED Lifetime	30,000 hours
Operating Temperature	-4°-104° F (-20°-40° C)

24 V Single Color/CCT STN Model	STN-AxK90-O32-O8L5M-24V						STN-Bx-O32A-O8L5M-24V
	2200K	2700K	3000K	4000K	5000K	6500K	
Brightness	3,550 lm	3,900 lm	4,550 lm	4,950 lm	5,400 lm	5,750 lm	N/A
Intensity	216 lm/ft	238 lm/ft	277 lm/ft	302 lm/ft	329 lm/ft	351 lm/ft	N/A
CRI	90+						N/A
LED Density	156 LEDs/ft (512 LEDs/m)						
Wattage	50 W (3.05 W/ft)						
Current Draw	2.08 A (127 mA/ft)						

24 V Single Color/CCT STW Model	STW-AxK90-O32D-O8L5M-24V						STW-Bx-O32D-O8L5M-24V
	2200K	2700K	3000K	4000K	5000K	6500K	
Brightness	2,950 lm	3,700 lm	3,750 lm	4,150 lm	4,250 lm	4,450 lm	N/A
Intensity	180 lm/ft	226 lm/ft	229 lm/ft	253 lm/ft	259 lm/ft	271 lm/ft	N/A
CRI	90+						N/A
LED Density	156 LEDs/ft (512 LEDs/m)						
Wattage	50 W (3.05 W/ft)						
Current Draw	2.08 A (127 mA/ft)						

12 V Single Color/CCT STN Model	STN-AxK90-O18A-O8P5M-12V					
	2200K	2700K	3000K	4000K	5000K	6500K
Brightness	2,250 lm	2,745 lm	2,925 lm	3,375 lm	3,600 lm	3,600 lm
Intensity	137 lm/ft	167 lm/ft	178 lm/ft	206 lm/ft	220 lm/ft	220 lm/ft
CRI	90+					
LED Density	154 LEDs/ft (504 LEDs/m)					
Wattage	45 W (2.74 W/ft)					
Current Draw	3.75 A (229 mA/ft)					

Model	STN-CRGB-O63A-12R5M-24V	STN-H90-O42A-12Q5M-24V
Color	RGB	Selectable CCT (2700K-6500K)
LED Density	345 LEDs/ft (1,134 LEDs/m)	307 LEDs/ft (1,008 LEDs/m)
Wattage	75 W (4.57 W/ft)	86 W (5.24 W/ft)
Current Draw	3.13 A (191 mA/ft)	3.58 A (218 mA/ft)

Certifications

The strips are UL Listed in compliance with UL 2108. STN strips are listed for use in dry or damp locations, and STW strips are listed for use in wet locations.



Warranty

Five (5) year warranty.



COB Series LED Strip Lights

Single Color/CCT, Tunable CCT, and RGB Strips

Dimensions

STN-Bx-O32A-08L5M-xV/

STN-AxK90-O32-08L5M-xV

- 16.4 ft (5 m) max run

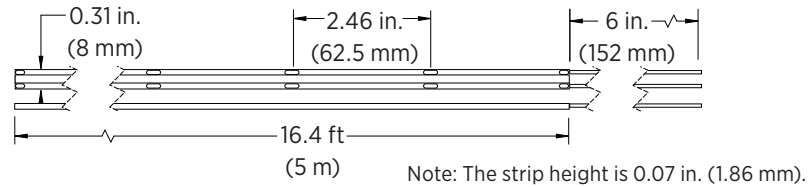

STN-H90-O42A-12Q5M-24V

- 16.4 ft (5 m) max run

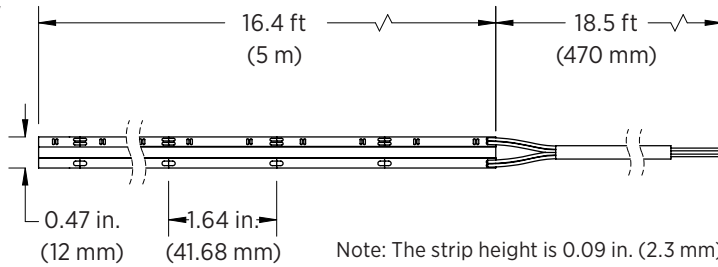

STN-CRGB-O63A-12R5M-24V

- 16.4 ft (5 m) max run

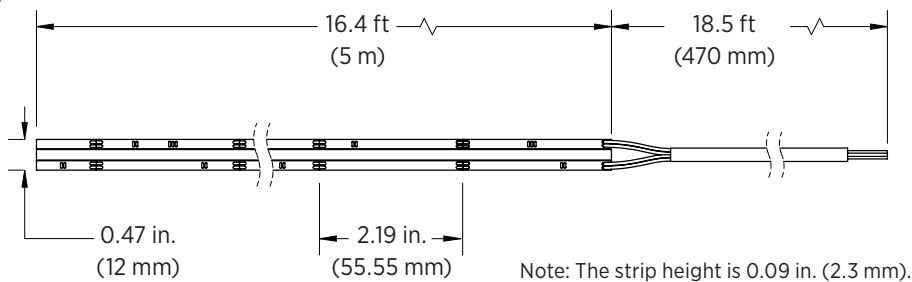

STW-Bx-O32D-08L5M-xV/

STW-AxK90-O32D-08L5M-xV

- 16.4 ft (5 m) max run

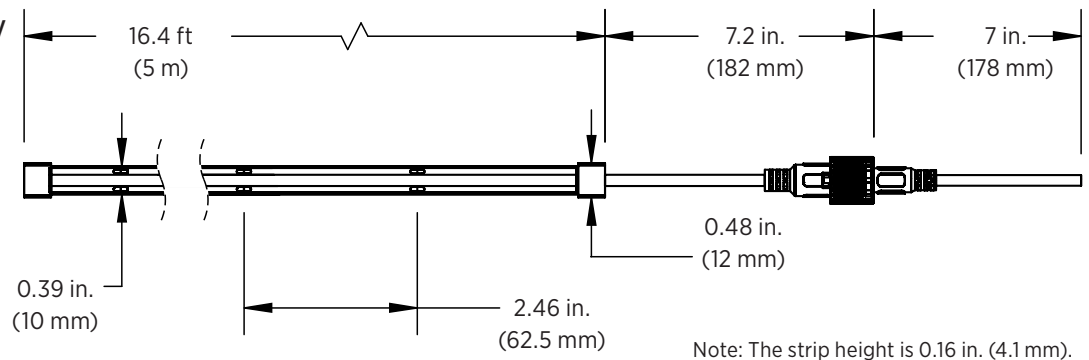

Strip Flexibility

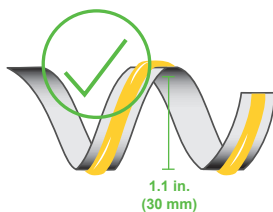

Bends less than 30 mm will damage circuit traces and void warranty.

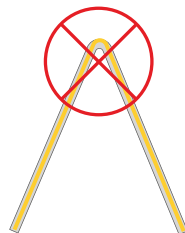

Bending strips at sharp angles will damage circuit traces and void warranty.

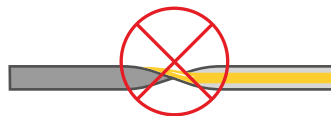

Twisting strips will damage circuit traces and void warranty.

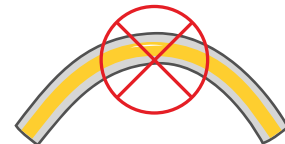

Bending strips on horizontal plane will damage circuit traces and void warranty.