

Important: Read all instructions prior to installation.

LED Bollard Light

Safety and Notes

WARNING—RISK OF FIRE, ELECTRIC SHOCK, INJURY, OR PROPERTY DAMAGE.

- To reduce the risk of electric shock, ensure that the main power source and circuit breakers are switched off before performing any installation or wiring procedures.
- Product should be installed and serviced by a certified electrician in accordance with applicable national, state, and local building and electrical codes.
- Ensure all mounts are securely attached and the foundation will support the weight of the fixture. Failure to properly support fixture may result in damage or injury, for which the manufacturer does not assume responsibility.
- Mount using the appropriate installation kit as offered by the manufacturer only.

CAUTION

- Edges may cut—wear gloves while handling or servicing this equipment.
- Inspect equipment for shipping damage before installation.
- Clean using a dry, soft cloth only. If necessary, use a mild detergent and luke warm water to remove grease. Do not use undiluted detergents or those that contain abrasives or sealants.

Specifications



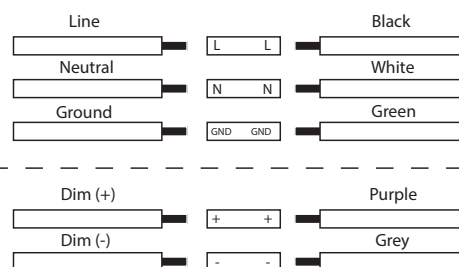

Check product label for specific electrical specifications related to installation. Improper installation will void warranty.

Wiring Diagram





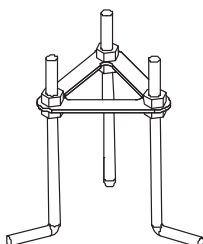

Installation Kits

BLRB-KIT

-  1 - Anchor Bolt Carrier
-  3 - Anchor Bolt
-  12 - Nut
-  3 - Spring Washer
-  6 - Flat Washer



BLSB-KIT

-  1 - Anchor Bolt Carrier
-  4 - Anchor Bolt
-  16 - Nut
-  4 - Spring Washer
-  8 - Flat Washer

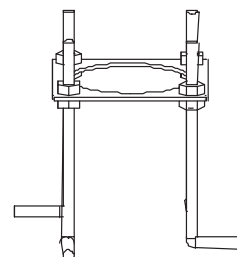

INSTALLATION

With electrical conduit in place, mount anchor bolts in concrete using the carrier to maintain proper spacing. Install so that 1.5–2 in. of the anchor bolt remains exposed above the surface.

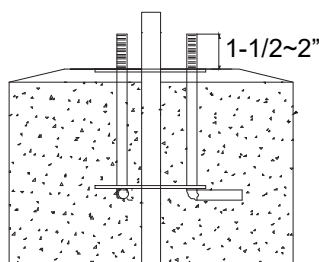

Important: Read all instructions prior to installation.

LED Bollard Light

Bollard Installation

1. With installation kit mounted and cement/concrete cured, mount bollard base using provided installation kit hardware and connect wiring using terminal block.

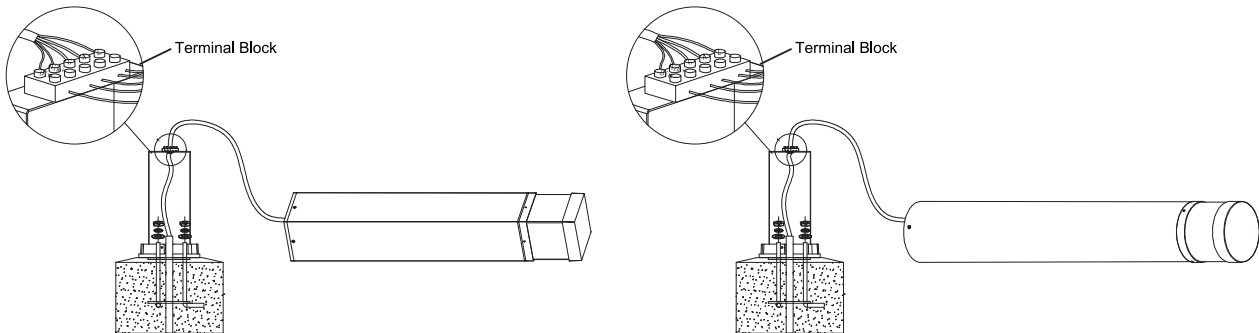

2. Rotate bollard and place in position over bollard base.



3. Tighten set screws to secure bollard to base.

