

## **SPECIFICATION FOR APPROVAL**

★ Commodity: 5050 SMD

★ Model No: 5050-R1200

★ Emission Color: Red

★ Lens Appearance: Water Clear

★ Quality & Safety Certification: RoHS

<b>CUSTOMER APPROVED BY</b>	<b>DATE</b>

● **Features**

- Chip Material: AlGaInP.
- Low Power Consumption.
- High Efficiency.
- Low Current Requirement.

● **Applications**

- Backlight.
- Traffic Lights.
- Lights.
- LED Display.
- Other Electric Products.

● **Package Dimensions**

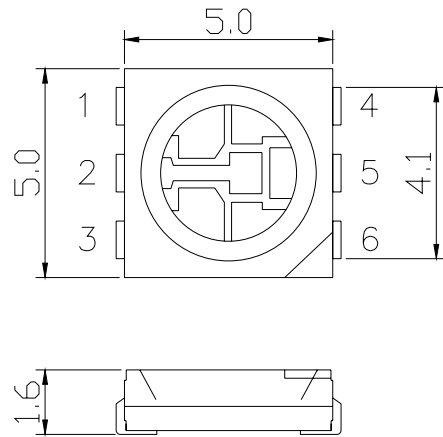

1/2/3.Anode. 4/5/6.Cathode.

Notes

- 1: All dimensions are in millimeters.
- 2: Tolerance is  $\pm 0.1$ mm unless otherwise specified.

● **Absolute Maximum Ratings (Ta=25°C)**

Parameter	Symbol	Rating	Unit
Power Dissipation	Pd	3X120	mW
Forward Current	I <sub>F</sub>	3X20	mA
Peak Forward Current* <sup>1</sup>	I <sub>FP</sub>	3X100	mA
Reverse Voltage	V <sub>R</sub>	5	V
Operating Temperature Range	T <sub>opr</sub>	-20~80	°C
Storage Temperature Range	T <sub>stg</sub>	-40~85	°C
Soldering Temperature	T <sub>sol</sub>	260 (for 5 seconds)	°C

● **Electrical And Optical Characteristics (Ta=25°C)**

Parameter	Symbol	Condition	Min	Typ	Max	Unit
Forward Voltage	$V_F$	$I_F=3 \times 20\text{mA}$	1.8	2.0	2.2	V
Luminous Intensity	$I_V$	$I_F=3 \times 20\text{mA}$	1000	1200	1400	mcd
Reverse Current	$I_R$	$V_R=5\text{V}$	-		10	$\mu\text{A}$
Dominant Wavelength	$\lambda_D$	$I_F=3 \times 20\text{mA}$	620	625	630	nm
Color Temperature	CCT	$I_F=3 \times 20\text{mA}$				K
Viewing Angle	$2\theta_{1/2}$	$I_F=3 \times 20\text{mA}$		120		deg

● **Typical Electro-Optical Characteristics Curves**

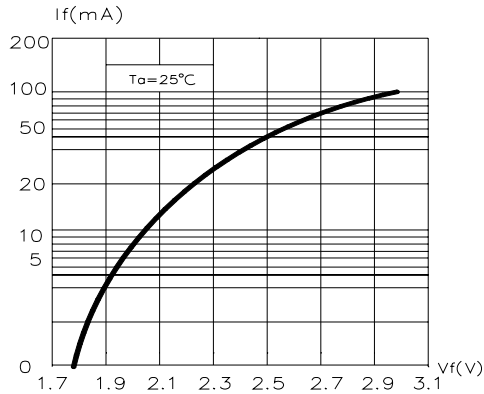

Fig.1 Forward Current vs. Forward Voltage

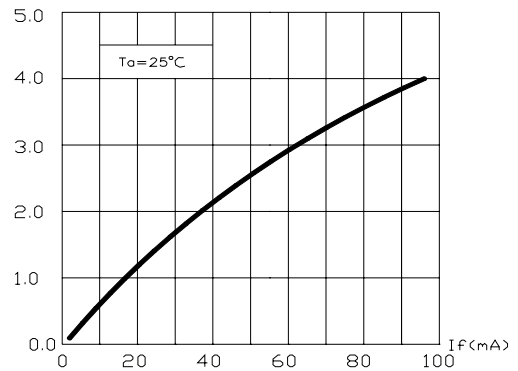

Fig.2 Relative Luminous Intensity vs. Forward Current

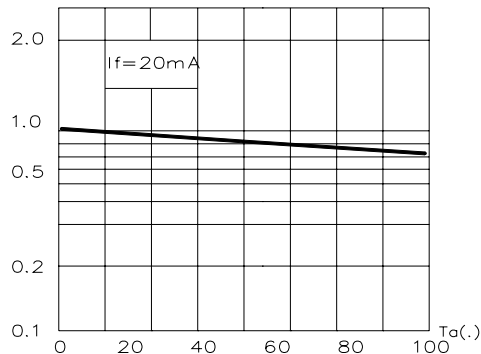

Fig.3 Relative Luminous Intensity vs. Ambient Temperature

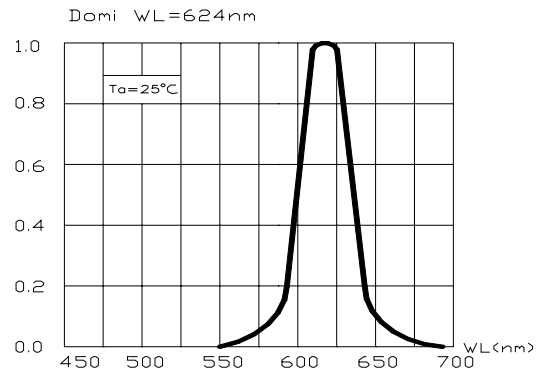

Fig.4 Relative Luminous Flux vs. Wavelength

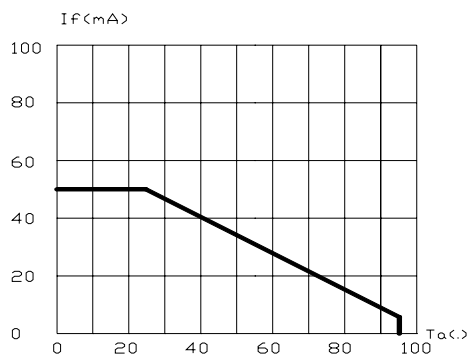

Fig.5 Maximum Forward Current vs. Ambient Temperature

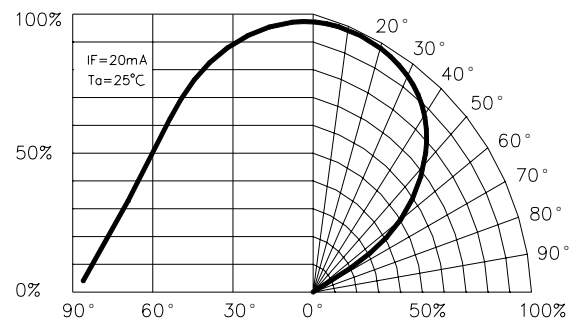

Fig.6 Relative Luminous Intensity vs. Radiation Angle