

SPECIFICATION FOR APPROVAL

- ★ **Commodity: 5050 SMD**
- ★ **Model No: 5050-PW6000**
- ★ **Emission Color: Pure White**
- ★ **Lens Appearance: Yellow**
- ★ **Quality & Safety Certification: RoHS**

CUSTOMER APPROVED BY	DATE

● **Features**

- Chip Material: InGaN.
- Low Power Consumption.
- High Efficiency.
- Low Current Requirement.

● **Applications**

- Backlight.
- Traffic Lights.
- Lights.
- LED Display.
- Other Electric Products.

● **Package Dimensions**

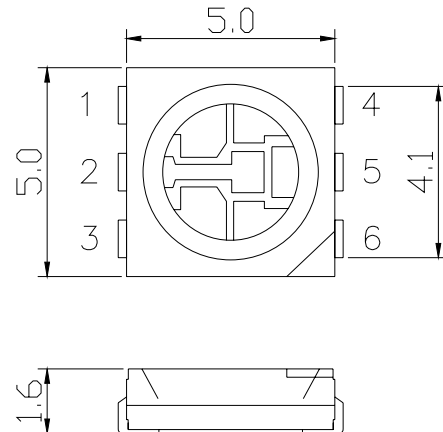

1/2/3.Anode. 4/5/6.Cathode.

Notes

- 1: All dimensions are in millimeters.
- 2: Tolerance is ± 0.1 mm unless otherwise specified.

● **Absolute Maximum Ratings (Ta=25°C)**

Parameter	Symbol	Rating	Unit
Power Dissipation	Pd	3X120	mW
Forward Current	I _F	3X20	mA
Peak Forward Current* ¹	I _{FP}	3X100	mA
Reverse Voltage	V _R	5	V
Operating Temperature Range	T _{opr}	-20~80	°C
Storage Temperature Range	T _{stg}	-40~85	°C
Soldering Temperature	T _{sol}	260 (for 5 seconds)	°C

● **Electrical And Optical Characteristics (Ta=25°C)**

Parameter	Symbol	Condition	Min	Typ	Max	Unit
Forward Voltage	V_F	$I_F=3 \times 20\text{mA}$	3.0	3.2	3.4	V
Luminous Intensity	I_V	$I_F=3 \times 20\text{mA}$	5000	6000	7000	mcd
Reverse Current	I_R	$V_R=5\text{V}$	-		10	μA
Dominant Wavelength	λ_D	$I_F=3 \times 20\text{mA}$		Pure White		nm
Color Temperature	CCT	$I_F=3 \times 20\text{mA}$	5500		7500	K
Viewing Angle	$2\theta_{1/2}$	$I_F=3 \times 20\text{mA}$		120		deg

● **Typical Electro-Optical Characteristics Curves**

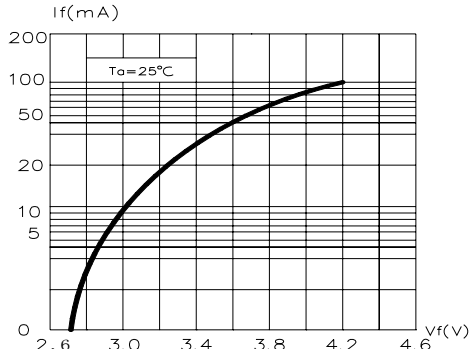

Fig.1 Forward Current vs. Forward Voltage

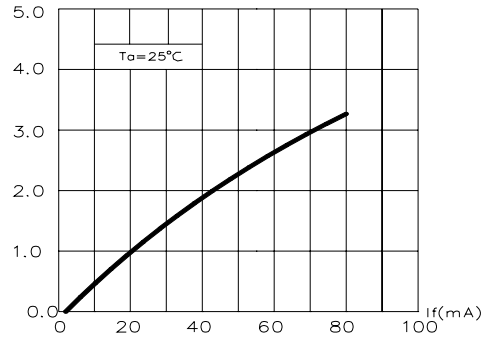

Fig.2 Relative Luminous Intensity vs. Forward Current

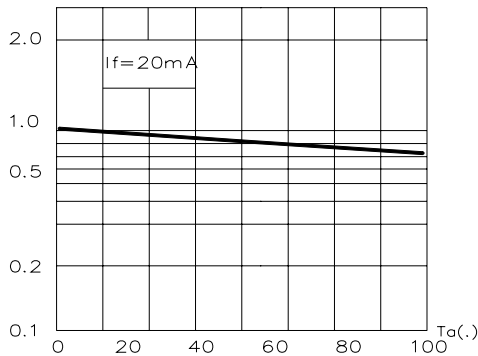

Fig.3 Relative Luminous Intensity vs. Ambient Temperature

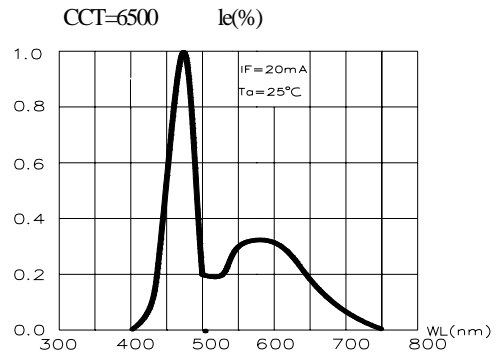

Fig.4 Intensity Vs. Wavelength.

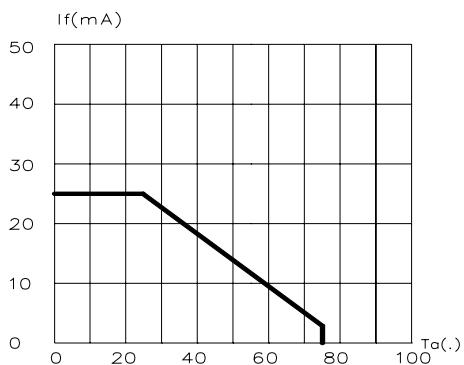

Fig.5 Maximum Forward Current vs. Ambient Temperature

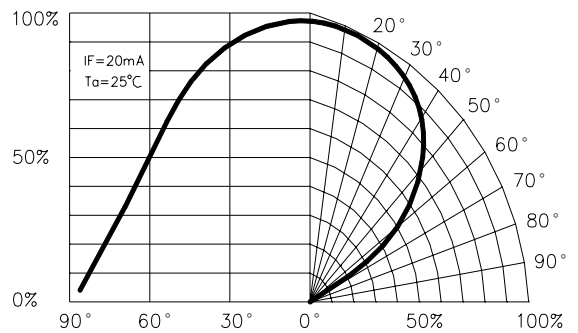

Fig.6 Relative Luminous Intensity vs. Radiation Angle